

# ROUND Cylinders



Find out our  
key products



**Solution for most applications**



**Easy and intuitive choice**



**Excellent value for money**



**Wide availability**



**Fast delivery**



## Features and certifications

Series of round cylinders not conforming to standards, available in bores from Ø 32 to 63, single acting or double acting, magnetic or non magnetic, with or without cushioning. The heads joined to the barrel through rolling ensure perfect tightening. Supplied as standard in compliance with Reach and RoHS directives, and SIL certificated. On request, they can be also supplied according to the 2014/34/EU ATEX Directive.



### Type RS Ø 32 ÷ 63

from page 1.11.20



Round cylinders not conforming to standards, available in bores from Ø 32 to 63, single acting, non magnetic. Heads joined to the barrel through rolling ensure perfect tightening. Supplied with rod nut and head nut.

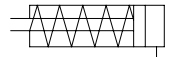

### Type RD Ø 32 ÷ 63

from page 1.11.40



Round cylinders not conforming to standards, available in bores from Ø 32 to 63, double acting, non magnetic. Heads joined to the barrel through rolling ensure perfect tightening. Supplied with rod nut and head nut.

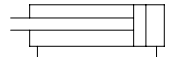

### Type RDM Ø 32 ÷ 63

from page 1.11.40



Round cylinders not conforming to standards, available in bores from Ø 32 to 63, double acting, magnetic. Heads joined to the barrel through rolling ensure perfect tightening. Supplied with rod nut and head nut. Possibility of applying one or more magnetic reed switches.

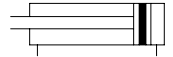

### Type RDMA Ø 32 ÷ 63

from page 1.11.60



Round cylinders not conforming to standards, available in bores from Ø 32 to 63, double acting, magnetic, adjustable cushioning. Heads joined to the barrel through rolling ensure perfect tightening. Supplied with rod nut and head nut. Possibility of applying one or more magnetic reed switches.

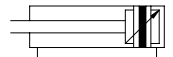

Options		
Description	Symbol	Suffix
Through rod (not available for RS type)		<b>P</b>
Rear spring (available only for RS type)		<b>T</b>
FKM seals	-20°C ÷ +150°C 	<b>V</b>
Low temperature seals	-40°C ÷ +80°C 	<b>BT</b>
Low friction		<b>L</b>
Special male thread (indicate the requested thread. E.g.: R-M 10x1,5; the dimension AM of the special thread will be the same as the standard; cylinder will be supplied without rod nut; for further information please contact the sales department)		<b>R-M..</b>
ATEX versions on request		<b>/ATEX</b>
Special versions on request		<b>/S</b>

The options, when this is possible, can be combined with each other. For options matching see from page 1.11.4; For code key see from page 1.11.5

## Options matching

Series	Bore	Model	Standard options matching						
			P	T	V	BT	L	R-M.. <sup>(1)</sup>	/ATEX
RS	Ø 32 ÷ 63	Standard	-	●	●	●	●	●	●
		Rear spring (T)	-		●	●	●	●	●
		Low friction (L)	-	●	●	●		●	●
RD-RDM	Ø 32 ÷ 63	Standard	●	-	●	●	●	●	●
		Through rod (P)		-	●	●	●	●	●
		Low friction (L)	●	-	●	●		●	●
RDMA	Ø 32 ÷ 63	Standard	●	-	●	●	●	●	●
		Through rod (P)		-	●	●	●	●	●
		Low friction (L)	●	-	●	●		●	●

### Key

● matching accessory; - not matching accessory

## Options matching - notes

(1) Option **R-M..** require to indicate the desired thread. For further information please contact the sales department.

## Standard materials

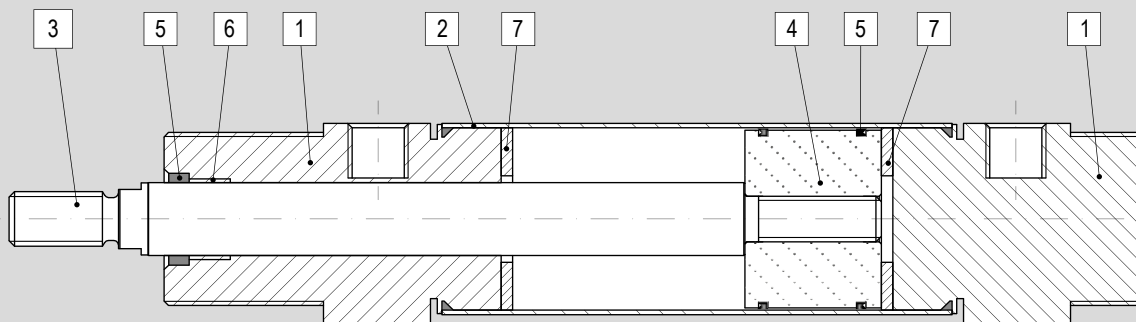

Position	Description	Materials
1	Heads	Anodised aluminium
2	Tube	Stainless Steel AISI 304
3	Rod	Stainless Steel AISI 303
4	Piston	Aluminium
5	Seals	NBR / Polyurethane (PU)
6	Bushing	Self-lubricating sintered bronze
7	Dumper	NBR

## Code key

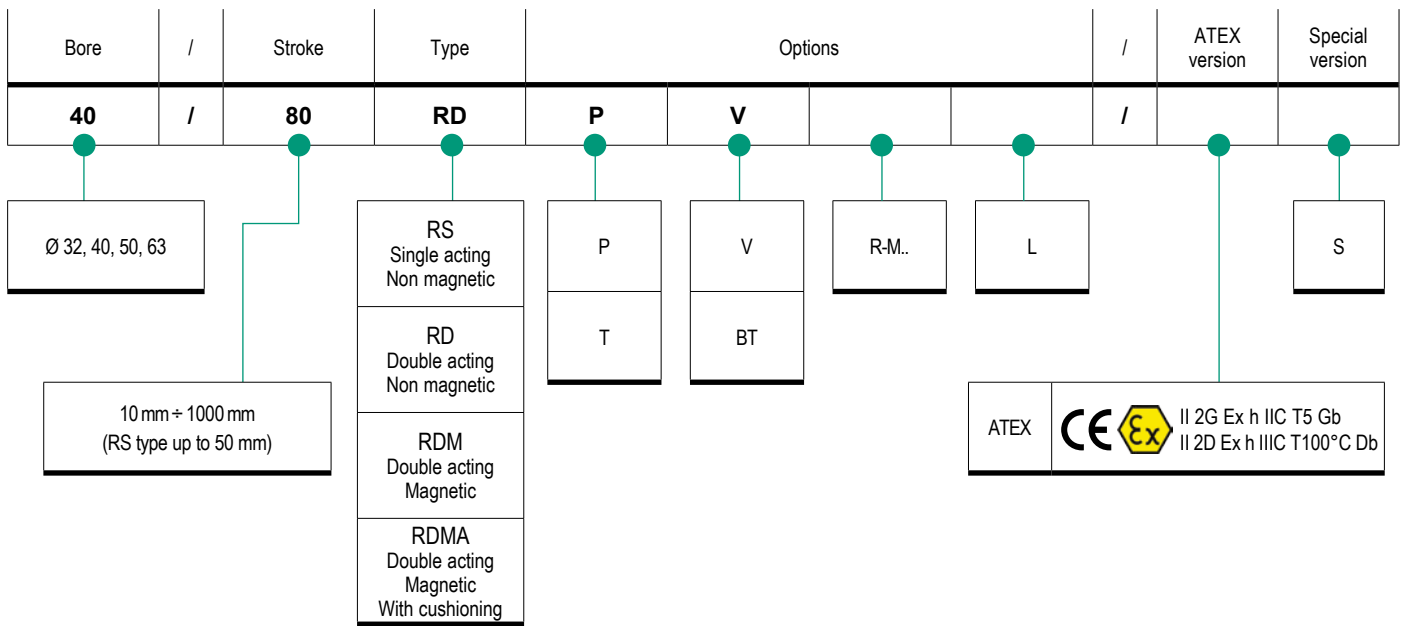

## How to order

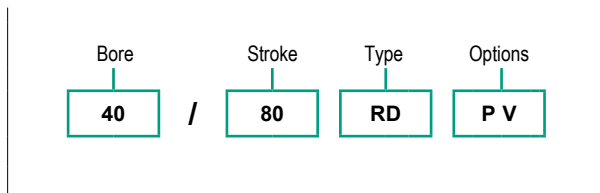

## Notes

Options in the same grid are alternative to each others.  
 For further information on options and their matching, see page 1.11.3 and 1.11.4  
 For further information on the ATEX 2014/34/EU Directive, on classifications and protections, see from page III.1

Accessories

1 - CYLINDERS

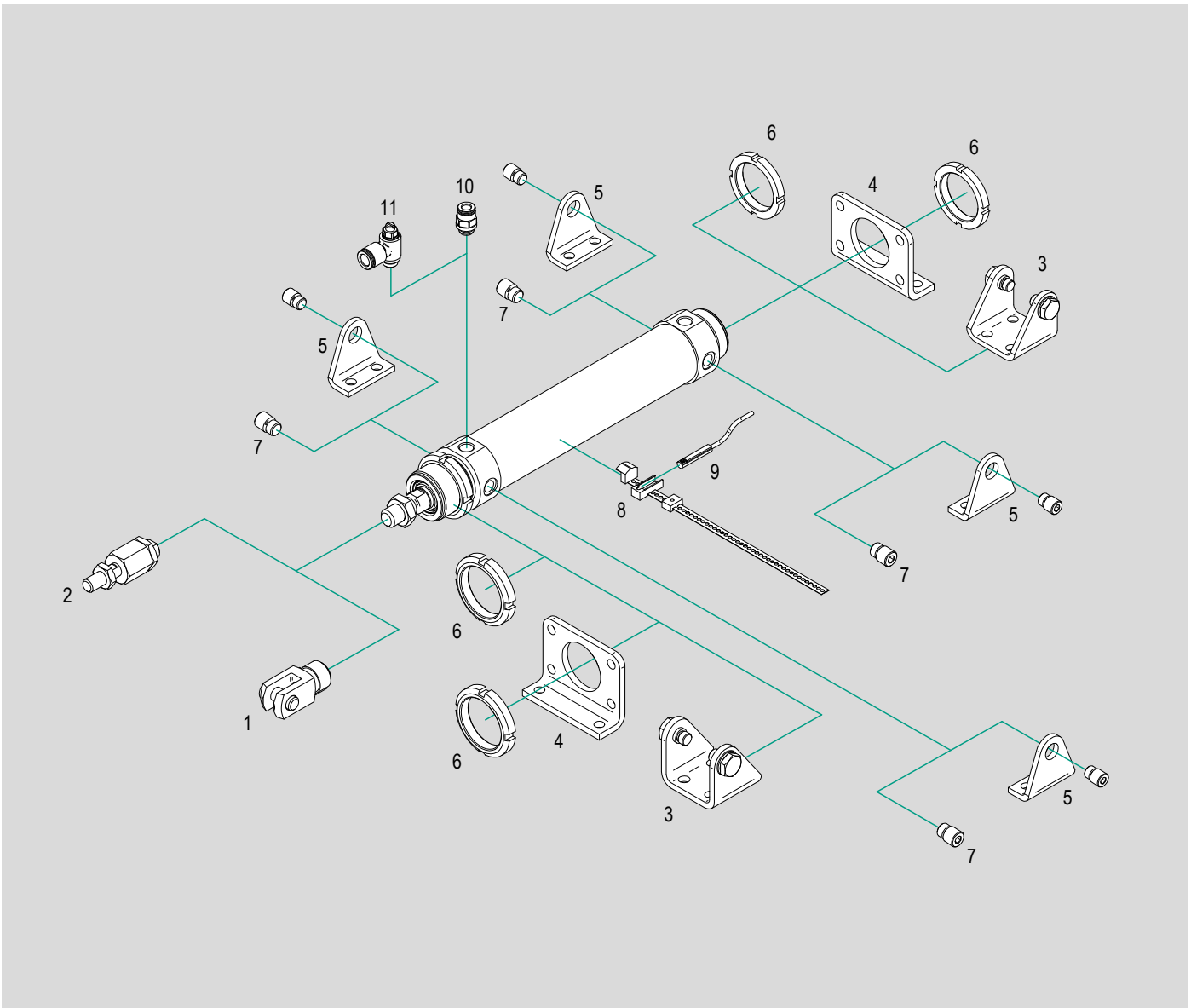

N.	Cylinder bore	Item	Description	Compliance	Matching				Code page	Data sheet page
					RS	RD	RDM	RDMA		
1	Ø 32 ÷ 63	FF..	DIN female clevis with clip	DIN 71752	●	●	●	●	1.11.90	1.86.1
		FFP..	DIN female clevis with pin and seeger		●	●	●	●		1.86.2
		FFN..	DIN female clevis (body only)		●	●	●	●		1.90.10
2	Ø 32 ÷ 63	GB..	Bearing - Self-aligning articulated coupling	-	●	●	●	●	1.90.10	
3	Ø 32 ÷ 63	CF..	Rear clevis	-	●	●	●	●	1.96.1	
4	Ø 32 ÷ 63	P..	Foot-flange	-	●	●	●	●	1.96.2	
5	Ø 32 ÷ 63	CP..	Foot-hinge	-	●	●	●	●	1.96.3	
6	Ø 32 ÷ 63	GH..	Heads nut	-	●	●	●	●	1.120.1	
7	Ø 32 ÷ 63	SEC..	Pins	-	●	●	●	●	1.110.10	
		AFR..	Bracket for T type magnetic reed switches	-	-	●	●	1.113.1		
8	Ø 32 ÷ 63	ASV..	Magnetic reed switch T groove	2014/34/EU	-	-	●	●	4.2.1	
		MK..	ATEX magnetic reed switch T groove		-	-	●	●	4.94.1	
9	Ø 32 ÷ 63	R..	Push-in fittings	-	●	●	●	●	4.2.1	
10	Ø 32 ÷ 63	V..C	Flow controls, for cylinders	-	●	●	●	●	4.94.1	

Key  
 ● matching accessory; - not matching accessory

# Round cylinders

## Series RS



### Main features

32 ÷ 63

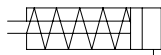

**RS**

Bores Ø

Single acting  
Non magnetic

Type



### Technical data

Bore Ø mm	32	40	50	63									
Fluid	Filtered compressed air with or without lubrication. Lubrication, if started, must be continued.												
Pressure range	1 ÷ 10 bar												
Temperature range	-20°C ÷ +80°C (standard)	-20°C ÷ +150°C (V)	-40°C ÷ +80°C (BT)										
Strokes	10 ÷ 50 mm												
Rod thread	M10x1,5	M12x1,75	M16x2										
Thrust force at 6 bar (N)	482	754	1178	1869									
Traction force (N)	Stroke (mm)	10	25	50	10	25	50	10	25	50	10	25	50
	min.	57	51	40	98	86	64	147	130	101	147	130	101
	max.	62	62	62	105	105	105	158	158	158	158	158	158

### Standard strokes

Stroke mm	<b>RS</b> Bore Ø mm			
	32	40	50	63
10				
25				
50				

Key

□ Standard stroke

Standard dimensions

1 - CYLINDERS

Type: **RS**

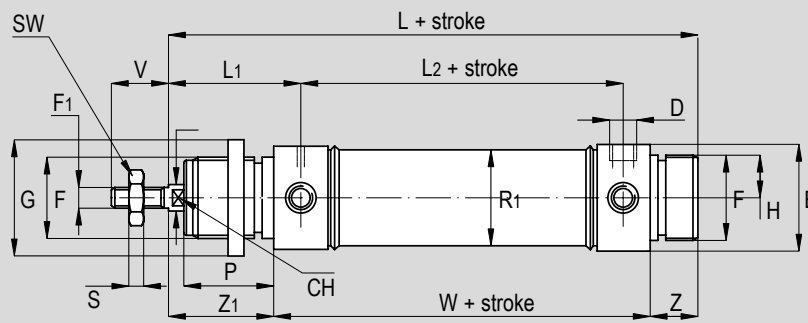

∅ (mm)	V	F	P	D	F <sub>1</sub>	R	L <sub>2</sub>	Z	Z <sub>1</sub>	W	L <sub>1</sub>	L	R <sub>1</sub>	H	S	∅B	CH	SW	∅G
32	20	M30x1,5	30	1/8"	M10x1,5	12	78	14	38	96	47	148	33,6	17,5	6	38	10	17	45
40	24	M38x1,5	35	1/4"	M12x1,75	16	89	16	45	113	57	174	41,6	21	7	46	13	19	50
50	32	M45x1,5	38	1/4"	M16x2	20	96	18	50	120	62	188	52,4	26,5	8	57	17	24	58
63	32	M45x1,5	38	3/8"	M16x2	20	98	18	50	124	63	192	65,4	32,5	8	70	17	24	58



# Round cylinders

## Series RD - RDM



### Main features

32 ÷ 63

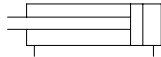

**RD**

Bores Ø

Double acting  
Non magnetic

Type



32 ÷ 63

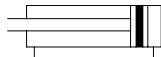

**RDM**

Bores Ø

Double acting  
Magnetic

Type



### Technical data

Bore Ø mm	32	40	50	63
Fluid	Filtered compressed air with or without lubrication. Lubrication, if started, must be continued.			
Pressure range	1 ÷ 10 bar			
Temperature range	-20°C ÷ +80°C (standard)	-20°C ÷ +150°C (V)	-40°C ÷ +80°C (BT)	
Standard strokes	25 ÷ 1000 mm			
Rod thread	M10x1,5	M12x1,75	M16x2	

### Standard strokes

Stroke mm	<b>RD</b> Bore Ø mm			
	32	40	50	63
25				
50				
80				
100				
125				
160				
200				
250				
320				
400				
500				

Stroke mm	<b>RDM</b> Bore Ø mm			
	32	40	50	63
25				
50				
80				
100				
125				
160				
200				
250				
320				
400				
500				

Key  
 Standard stroke

Standard dimensions

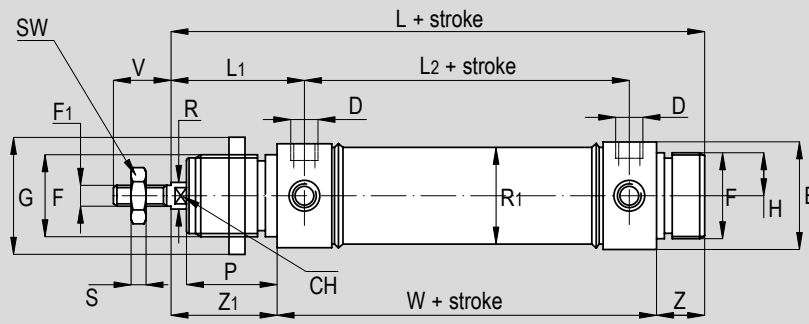

Type: RD - RDM

Ø (mm)	V	F	P	D	F <sub>1</sub>	R	L <sub>2</sub>	Z	Z <sub>1</sub>	W	L <sub>1</sub>	L	R <sub>1</sub>	H	S	ØB	CH	SW	ØG
32	20	M30x1,5	30	G1/8"	M10x1,5	12	78	14	38	96	47	148	33,6	17,5	6	38	10	17	45
40	24	M38x1,5	35	G1/4"	M12x1,75	16	89	16	45	113	57	174	41,6	21	7	46	13	19	50
50	32	M45x1,5	38	G1/4"	M16x2	20	96	18	50	120	62	188	52,4	26,5	8	57	17	24	58
63	32	M45x1,5	38	G3/8"	M16x2	20	98	18	50	124	63	192	65,4	32,5	8	70	17	24	58

Dimensions with options

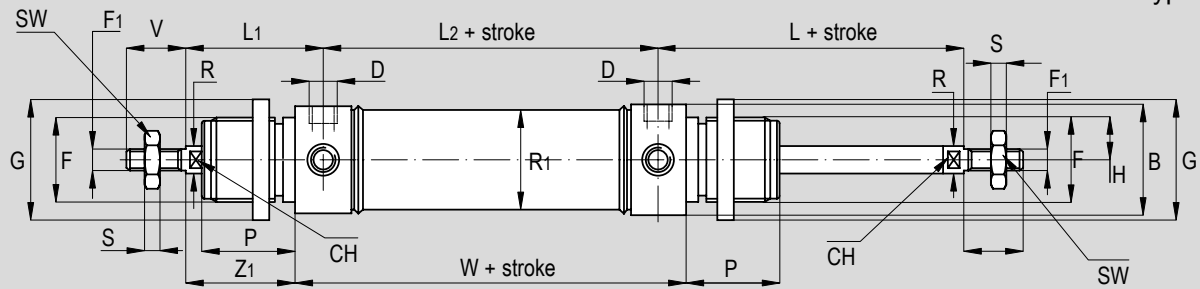

Type: ...P

Ø (mm)	V	F	P	D	F <sub>1</sub>	R	L <sub>2</sub>	Z <sub>1</sub>	W	L	L <sub>1</sub>	R <sub>1</sub>	H	S	ØB	CH	SW	ØG
32	20	M30x1,5	30	G1/8"	M10x1,5	12	78	38	96	47	47	33,6	17,5	6	38	10	17	45
40	24	M38x1,5	35	G1/4"	M12x1,75	16	89	45	113	57	57	41,6	21	7	46	13	19	50
50	32	M45x1,5	38	G1/4"	M16x2	20	96	50	120	62	62	52,4	26,5	8	57	17	24	58
63	32	M45x1,5	38	G3/8"	M16x2	20	98	50	124	63	63	65,4	32,5	8	70	17	24	58

# Round cylinders

## Series RDMA



### Main features

32 ÷ 63

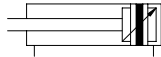

**RDMA**

Bores Ø

Double acting  
Magnetic  
With cushioning

Type



### Technical data

Bore Ø mm	32	40	50	63
Fluid	Filtered compressed air with or without lubrication. Lubrication, if started, must be continued.			
Pressure range	1 ÷ 10 bar			
Temperature range	-20°C ÷ +80°C (standard)	-20°C ÷ +150°C (V)	-40°C ÷ +80°C (BT)	
Strokes	25 ÷ 1000 mm			
Rod thread	M10x1,5	M12x1,75	M16x2	

### Standard strokes

Stroke mm	<b>RDMA</b> Bore Ø mm			
	32	40	50	63
25				
50				
80				
100				
125				
160				
200				
250				
320				
400				
500				

Key

□ Standard stroke

Standard dimensions

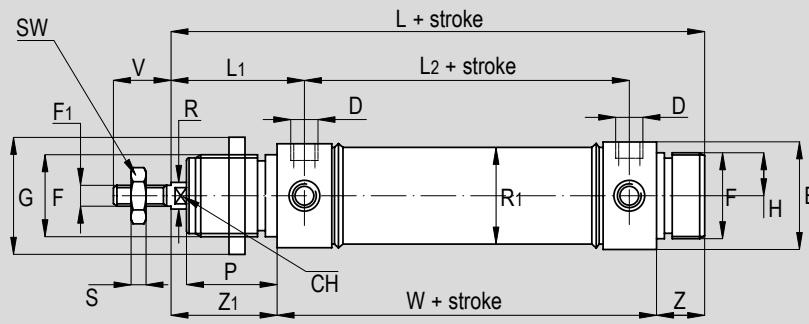

Type: **RDMA**

∅ (mm)	V	F	P	D	F <sub>1</sub>	R	L <sub>2</sub>	Z	Z <sub>1</sub>	W	L <sub>1</sub>	L	R <sub>1</sub>	H	S	∅B	CH	SW
32	20	M30x1,5	30	G1/8"	M10x1,5	12	78	14	38	96	47	148	33,6	17,5	6	38	10	17
40	24	M38x1,5	35	G1/4"	M12x1,75	16	89	16	45	113	57	174	41,6	21	7	46	13	19
50	32	M45x1,5	38	G1/4"	M16x2	20	96	18	50	120	62	188	52,4	26,5	8	57	17	24
63	32	M45x1,5	38	G3/8"	M16x2	20	98	18	50	124	63	192	65,4	32,5	8	70	17	24

Dimensions with options

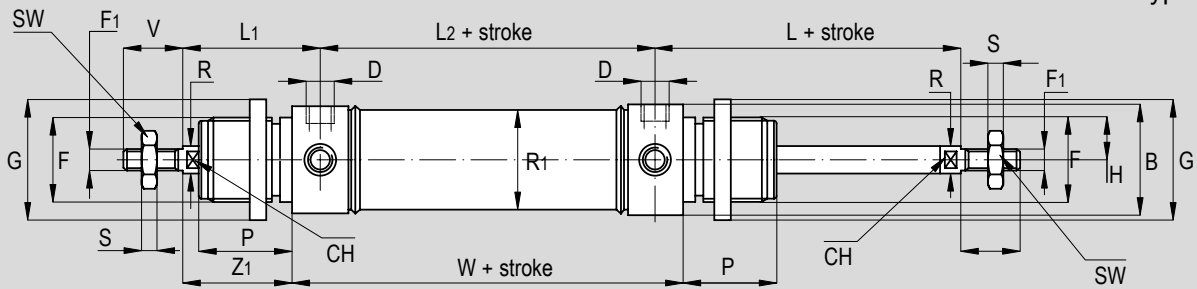

Type: **...P**

∅ (mm)	V	F	P	D	F <sub>1</sub>	R	L <sub>2</sub>	Z <sub>1</sub>	W	L	L <sub>1</sub>	R <sub>1</sub>	H	S	∅B	CH	SW	∅G
32	20	M30x1,5	30	G1/8"	M10x1,5	12	78	38	96	47	47	33,6	17,5	6	38	10	17	45
40	24	M38x1,5	35	G1/4"	M12x1,75	16	89	45	113	57	57	41,6	21	7	46	13	19	50
50	32	M45x1,5	38	G1/4"	M16x2	20	96	50	120	62	62	52,4	26,5	8	57	17	24	58
63	32	M45x1,5	38	G3/8"	M16x2	20	98	50	124	63	63	65,4	32,5	8	70	17	24	58

## Female clevis with clip FF..DIN

	For cylinder Ø mm	Code	Item	Compliance
	32	041025	FF10DIN	
	40	041026	FF12DIN	
	50	041028	FF16DIN	
	63			

## Female clevis with pin and seeger FFP..DIN

	For cylinder Ø mm	Code	Item	Compliance
	32	041096	FFP10DIN	
	40	041217	FFP12DIN	
	50	041213	FFP16DIN	
	63			

## Female clevis (body only) FFN..DIN

	For cylinder Ø mm	Code	Item	Compliance
	32	041020	FFN10DIN	
	40	041203	FFN12DIN	
	50	041202	FFN16DIN	
	63			

## Self-aligning articulated coupling GB..

	For cylinder Ø mm	Code	Item	Compliance
	32	041705	GB050	-
	40	041707	GB090	

## Rear clevis in steel with pins CF..AQM+P

	For cylinder Ø mm	Code	Item	Compliance
	32	040058	CF032AQM+P	-
	40	040059	CF040AQM+P	
	50	040060	CF050AQM+P	
	63	040061	CF063AQM+P	

Kit composed by one clevis and two pins.

## Foot-flange in steel P..AQM

	For cylinder Ø mm	Code	Item	Compliance
	32	040054	P032AQM	-
	40	040055	P040AQM	
	50	040056	P050AQM	
	63	040057	P063AQM	

For mounting on cylinder require heads nut GH..AQM, see below.

## Foot-hinge in steel with pin CP..AQM+P

	For cylinder Ø mm	Code	Item	Compliance
	32	040170	CP032AQM+P	-
	40	040171	CP040AQM+P	
	50	040172	CP050AQM+P	
	63	040173	CP063AQM+P	

Kit composed by two foot-hinge supplied with pins.

## Pin in steel SEC..AQM



	For cylinder Ø mm	Code	Item	Compliance
	32	040062	SEC032AQM	-
	40	040063	SEC040AQM	
	50	040064	SEC050AQM	
	63	040065	SEC063AQM	

Kit composed by two pins.

## Head nuts in steel GH..AQM



	For cylinder Ø mm	Code	Item	Compliance
	32	040066	GH032AQM	-
	40	040067	GH040AQM	
	50-63	040068	GH050/063AQM	

## Magnetic reed switch T groove ASV..

	For cylinder Ø mm	Code	Item	Cylinder matching
	32 ÷ 63	070946 	ASV1C525	RDM* RDMA*
		071863	ASV1C550	
		071864	ASV1C51K	
		071189	ASV1C5M8	
		073639	ASV4D225	
		070246 	ASV4D2M8	
		070247	ASV7N2M8	
		070372	ASV7M2M8	
		072918	ASV1H525	

\*With bracket type AFR1063 for magnetic reed switches T groove

## ATEX magnetic reed switch T groove MK..

	For cylinder Ø mm	Code	Item	Compliance	Cylinder matching
	32 ÷ 63	071120	MK500A		RDM* RDMA*
		071108	MK502A		

\*With bracket type AFR1063 for magnetic reed switches T groove

## Bracket AFR.. for magnetic reed switches T groove

	For cylinder Ø mm	Code	Item	Compliance
	32 ÷ 63	072907	AFR1063	-